

Group 8

Workbenches

Non-slip floor matting

Swivel chairs





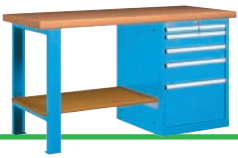

Series 40

Workbenches

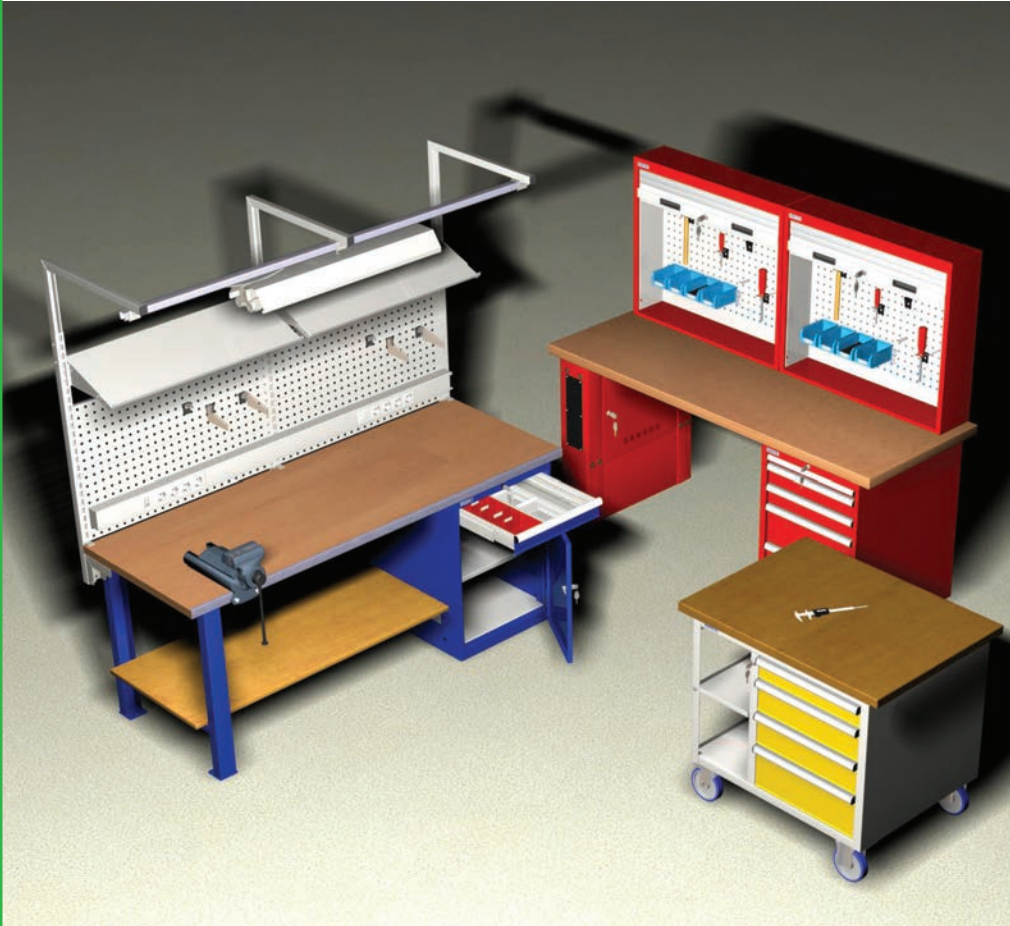

Workbenches
see page 232



Static and mobile workbenches
see page 254



Workbenches for Electronics Industry
see page 260



Chairs and non-slip floor matting
see page 264

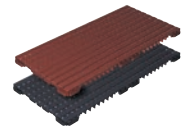

Standard colours:

RAL 5012 RAL 6011 RAL 7035 RAL 9010



Technical specifications

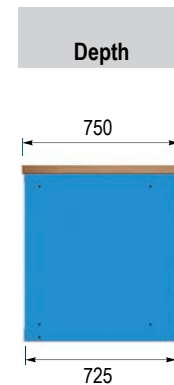
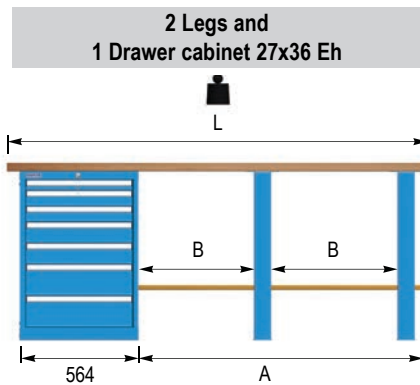
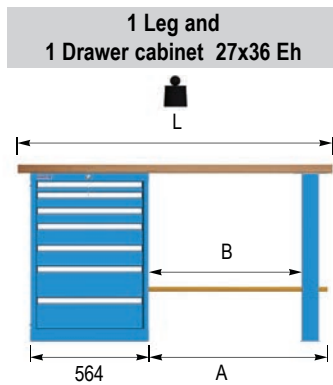

Width L mm	Multiplex worktop		MDF worktop		Laminated worktop	Linoplex worktop	No. of legs	Underslung shelf length	Usable length
	40 mm kg	50 mm kg	40 mm kg	50 mm kg	40 mm kg	40 mm kg		A mm	B mm
1250	1500	1500	1200	1200	—	1200	1	585	486
1500	1500	1500	1200	1200	650	1200	1	835	736
1750	1200	1500	1000	1200	—	1000	1	1085	986
2000	800	1000	650	800	350	650	1	1335	1236
2500	350	500	300	450	x	300	1	1835	1736
2500	1200	1500	1200	1200	650	1200	2	1835	828
3000	—	—	x	x	450	900	2	2335	1078



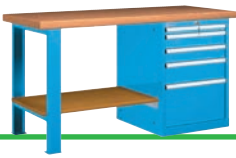

Series 40

Technical specifications

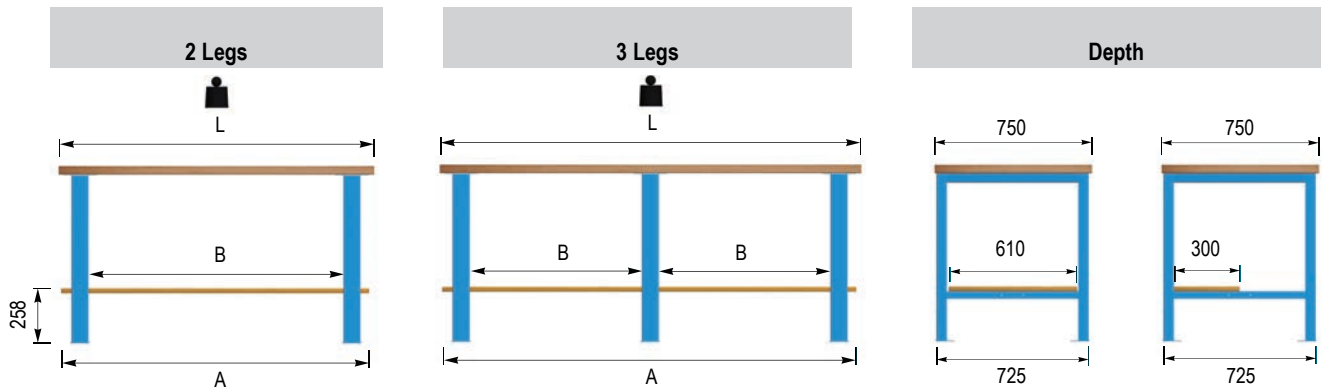

Width L mm	Multiplex worktop		MDF worktop		Laminated worktop 40 mm	Linoplex worktop 40 mm	No. of legs	No. of legs A	Usable length B
	40 mm kg	50 mm kg	40 mm kg	50 mm kg	kg	kg			
1250	1200	1500	1000	1200	—	1000	2	1170	970
1500	800	1000	650	800	350	650	2	1420	1220
1750	600	800	500	650	—	500	2	1670	1470
2000	350	500	300	450	x	300	2	1920	1720
2000	1500	1500	1200	1200	650	1200	3	1920	820
2500	x	350	x	300	x	x	2	2420	2220
2500	1200	1500	1000	1200	450	1000	3	2420	1070
3000	—	—	x	x	250	500	3	2x1460	1320



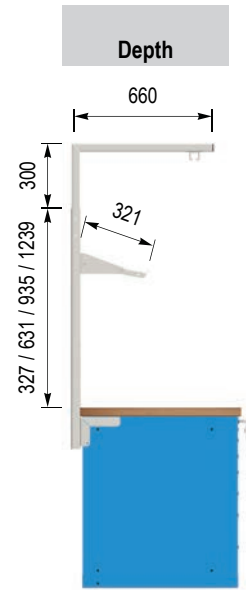
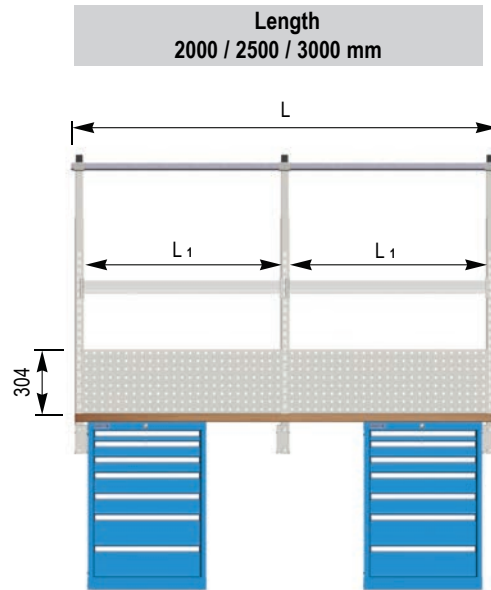
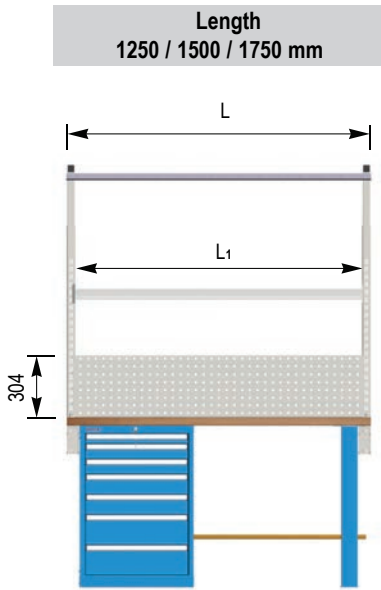

Length L mm	Length L ₁ mm
1250	1170
1500	1420
1750	1670
2000	1880
2500	2380
3000	2880

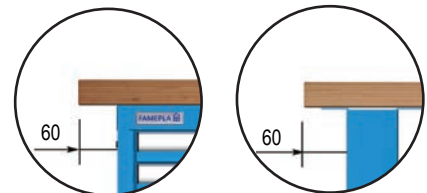
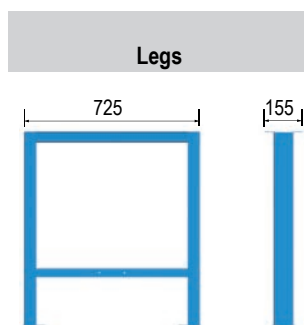

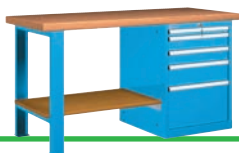

Series 40



Multiplex worktops



Multiplex worktops
with front galvanized profile capping

Length mm	Depth mm	Thickness 40 mm	Thickness 50 mm
		Part. No.	Part. No.
1250	750	40-40127	40-50127
1500	750	40-40157	40-50157
1750	750	40-40177	40-50177
2000	750	40-40207	40-50207
2500	750	40-40257	40-50257

Length mm	Depth mm	Thickness 40 mm	Thickness 50 mm
		Part. No.	Part. No.
1250	750	40-42127	40-52127
1500	750	40-42157	40-52157
1750	750	40-42177	40-52177
2000	750	40-42207	40-52207
2500	750	40-42257	40-52257

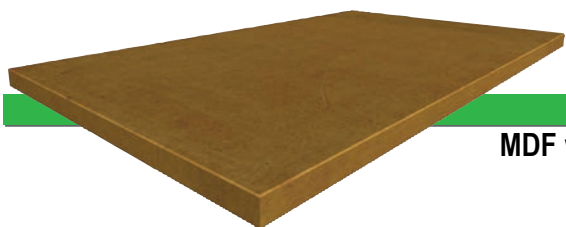

MDF worktops

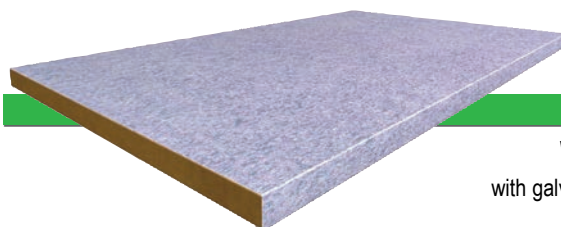

Worktops
with galvanized cover

Length mm	Depth mm	Thickness 40 mm	Thickness 50 mm
		Part. No.	Part. No.
1250	750	41-41127	41-51127
1500	750	41-41157	41-51157
1750	750	41-41177	41-51177
2000	750	41-41207	41-51207
2500	750	41-41257	41-51257
3000	750	41-41307	41-51307

Length mm	Depth mm	Thickness 40 mm	Thickness 50 mm
		Part. No.	Part. No.
1250	750	40-43127	40-53127
1500	750	40-43157	40-53157
1750	750	40-43177	40-53177
2000	750	40-43207	40-53207
2500	750	40-43257	40-53257
*3000	750	40-43307	40-53307

* 2 pieces length 1500 mm



Linoplex worktops



Plastic laminated worktops

Length mm	Depth mm	Thickness 40 mm Part. No.	Thickness 50 mm Part. No.
1250	750	40-49127	-
1500	750	40-49157	-
1750	750	40-49177	-
2000	750	40-49207	-
2500	750	40-49257	-
3000	750	40-49307	-

Length mm	Depth mm	Thickness 40 mm Part. No.	Thickness 50 mm Part. No.
1500	750	40-48157	-
2000	750	40-48207	-
2500	750	40-48257	-
3000	750	40-48307	-

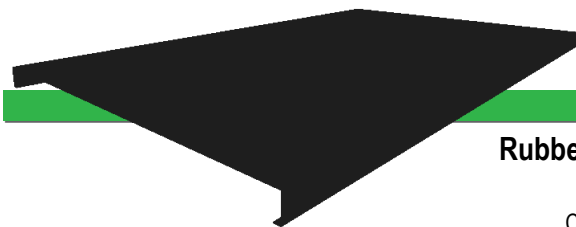

**Rubber covers
for tops**

Colour: Black

Length mm	Depth mm	Thickness 40 mm Part. No.	Thickness 50 mm Part. No.
1250	750	40-41127	40-51127
1500	750	40-41157	40-51157
1750	750	40-41177	40-51177
2000	750	40-41207	40-51207
2500	750	40-41257	40-51257
* 3000	750	40-41307	40-51307
Pair of profiles	Part. No.	40-41001	40-51001

* PVC cover in 2 pieces

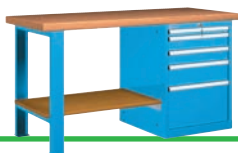

Series 40

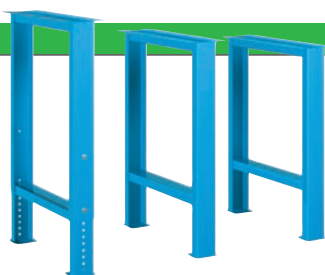

Workbench legs

Made of high-quality sheet steel. Welded steel profiles, painted with high resistance products, environmentally friendly. Available in different fixed or adjustable height* versions. For safety, legs should be secured to the floor by bolts.

Width mm	Depth mm	Height mm	Load capacity kg	Part. No.
80	725	800	400	40-68000
80	725	825	400	40-68200
80	725	850	400	40-68500
80	725	750-1050	400	*40-69000

Colours: see colour chart at the bottom of the page



Service legs

Made of high-quality sheet steel. Housing sides and bases are welded and painted with high resistance products, environmentally friendly. Fitted with one internal adjustable shelf. Leaf door fitted with safety cylinder lock and 2 keys.

Leg front open to insert covers or sockets.

Width mm	Depth mm	Height mm	Left hand opening Part. No.	Right hand opening Part. No.
190	725	800	40-78000	40-78010
190	725	825	40-78200	40-78210
190	725	850	40-78500	40-78510

Covers and sockets not included

Colours: see colour chart at the bottom of the page

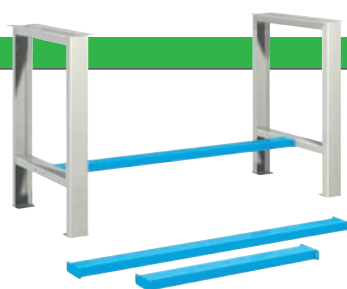

Connection bars

Made of high-quality sheet steel. To stabilise the workbench especially when legs are only used.

Worktop length mm	Connection bar length mm	Part. No.
1250	974	40-70012
1500	1224	40-70015
1750	1474	40-70017
2000	1724	40-70020
*2000	2 x 824	40-70021
2500	2224	40-70025
*2500	2 x 1074	40-70026
*3000	2 x 1324	40-70030

* with 3 legs, 2 connection bars are necessary

Colours: see colour chart at the bottom of the page



Covers and sockets

Made of high-quality steel



	Part. No.
without holes	40-75500
with 3 holes	40-75505
Socket block (4x Schuko 230 V) *	40-75520
Socket block (4x F 230 V) *	40-75522
Socket block (4x UK 240 V) *	40-75526

* on/off switch included

Different types of sockets are available on request



Vice cabinet

Made of high-quality sheet steel. Housing sides and bases are welded and painted with high resistance products.

Door fitted with cylinder lock.

Swivel and recessed steel vice (rotates 360 deg), adjustable height and equipped with 120 mm jaws.

Width mm	Depth mm	Height mm	without vice Part. No.	with vice Part. No.
310	725	800	40-88000	40-88001
310	725	825	40-88200	40-88210
310	725	850	40-88500	40-88510

Colours: see colour chart at the bottom of the page



Fixing material

for legs and Services legs

	Part. No.
Pre-assembled kit (for legs)	40-00012
Fixing hardware kit (for legs)	40-00013

6 bolts M10 and 6 threaded inserts for wood M10

Standard colours:

RAL 5012 RAL 6011 RAL 7035 RAL 9010



27 x 36 Eh



Cabinet housings

Made of high-quality sheet steel. Housing sides and bases are welded and painted with high resistance products, environmentally friendly. Available in different heights with uprights slotted in increments of 25 mm to allow drawers to be adjusted accordingly. Equipped with central locking system, safety cylinder lock with 2 keys and single drawer opening system.

Width mm	Depth mm	Height mm	Usable height mm	Part. No.
564	725	283	200	10-20280
564	725	383	300	10-20380
564	725	533	450	10-20530
564	725	800	700	10-20800
564	725	825	725	10-20820
564	725	850	750	10-20850
564	725	1000	900	10-21000

Colours: see colour chart at the bottom of the page



Cabinet bases

Made of high-quality steel

	Width mm	Depth mm	Height mm	Part. No.
1 Base plinth	564	693	50	05-42705
1 Base plinth	564	693	100	05-42710
1 Base plinth	564	693	130	05-42713

Colour: Black

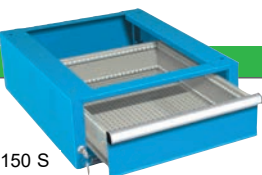

150 S

Workbench drawer

Made of high-quality steel

Width mm	Depth mm	Height mm	Extension %	Load capacity kg *	Part. No.
578	725	224	85	100	10-26200

* with load evenly distributed and at least one slotted divider in the middle

Colours: see colour chart at the bottom of the page

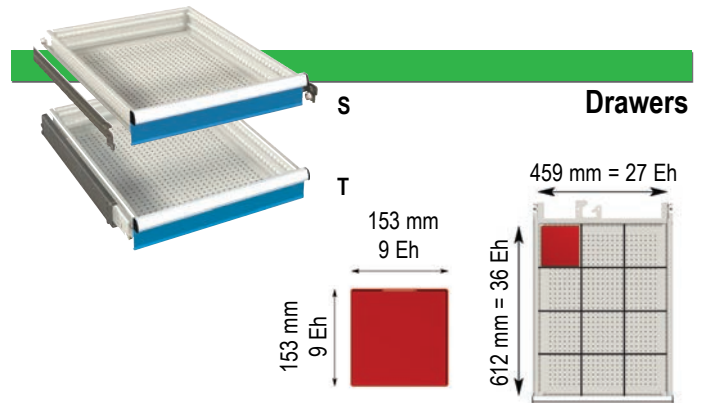

Made of high-quality sheet steel.

Available in two versions (simple or total extension) with steel roller bearings. All 4 drawer walls are slotted, for custom sub-division using partitioning material. All drawer handles are equipped with aluminium profiles, end caps and labelling strips.

Front height mm	Usable height mm	Lateral height mm	kg *	Part. No.
50 S	36	33	60	10-23050
75 S	61	52	80	10-23075
75 T	54	52	100	10-23076
100 S	86	77	100	10-23100
100 T	79	77	100	10-23101
125 S	111	77	100	10-23125
125 T	104	77	100	10-23126
150 S	136	127	100	10-23150
150 T	129	127	100	10-23151
200 S	186	177	100	10-23200
200 T	179	177	100	10-23201
250 S	236	177	100	10-23250
250 T	229	177	100	10-23251
300 S	286	277	100	10-23300
300 T	279	277	100	10-23301

S = simple extension: 85 - 90% extension

T = total extension: 100% extension

* with load evenly distributed and at least one slotted divider in the middle

Colour: Light grey RAL 7035 internal,

for drawer front see colour chart at the bottom of the page







Fixing material

for cabinets

	Part. No.
Pre-assembled kit (for cabinets)	40-00010
Fixing hardware kit (for cabinets)	40-00011
4 bolts M10 and 4 threaded inserts for wood M10	



Standard examples see page 240

Standard colours:
 RAL 5012  RAL 6011  RAL 7035  RAL 9010 

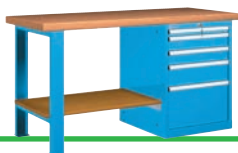

Series 40

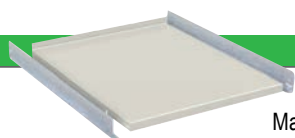

Adjustable shelf

Made of steel. Lateral supports included

Usable width mm	Usable depth mm	Height mm	Load capacity kg	Part. No.
505	620	35	70	10-20028

Colour: Light grey RAL 7035



Doors for cabinets

Made of high-quality steel

To be fitted to the cabinet, with safety cylinder lock and 2 keys (same number as in the cabinet).

Front height mm	Width mm	Right hand opening Part. No.	Left hand opening Part. No.
450	508	10-22451	10-22455
600	508	10-22601	10-22605

Colours: see colour chart at the bottom of the page

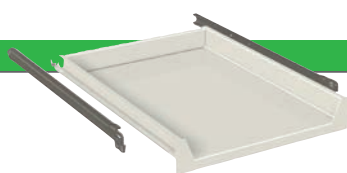

Retractable shelf

Made of high-quality steel

Usable width mm	Usable depth mm	Height mm	Extension %	Load capacity kg	Part. No.
434	612	100	85	70	10-23980

Colour: Light grey RAL 7035



Lower shelf

Made of high-quality steel

Usable width mm	Usable depth mm	Height mm	Load capacity kg	Part. No.
546	615	55	50	10-20034

Colour: Light grey RAL 7035

Standard colours:

RAL 5012 RAL 6011 RAL 7035 RAL 9010



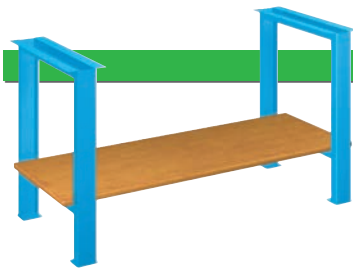

Underslung shelves

To be fitted between legs.
Thickness 30 mm

Worktop length mm	Underslung shelf length mm	Depth 600 mm Part. No.
1250	1170	40-26011
1500	1420	40-26014
1750	1670	40-26016
2000	1920	40-26019
2500	2420	40-26024
3000	2920	40-26029

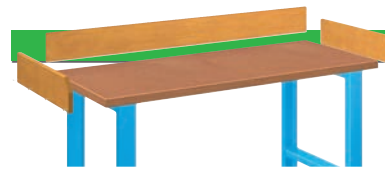

Side and rear upstands

Thickness 30 mm

Rear upstand

Width mm	Height mm	No. of pieces	Part. No.
1250	150	1	40-21512
1500	150	1	40-21515
1750	150	1	40-21517
2000	150	1	40-21520
2500	150	2	40-21525
3000	150	2	40-21530

Side upstand

Width mm	Height mm	Part. No.
770	150	40-21507

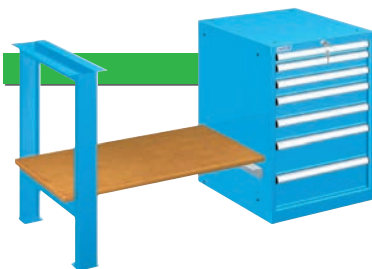

Underslung shelves

To be fitted between
1 cabinet and 1 leg.
Thickness 30 mm

Worktop length mm	Underslung shelf length mm	Depth 600 mm Part. No.
1250	585	40-26005
1500	835	40-26008
1750	1085	40-26010
2000	1335	40-26013
2500	1835	40-26018
3000	2335	40-26023



Top bench shelves

Thickness 30 mm

Top bench shelf

Width mm	Depth mm	No. of brackets	Part. No.
1250	300	2	40-23212
1500	300	2	40-23215
1750	300	3	40-23217
2000	300	3	40-23220
2500	300	3	40-23225
3000	300	4	40-23230

Brackets not included

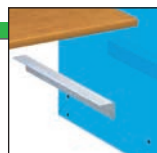

Support bracket

To be used when shelf is positioned
between 1 leg and 1 cabinet.

Depth	Part. No.
600	40-26001



Support bracket - adjustable

Made of steel. To be used in combination
with top bench shelves.

Depth mm	Height mm	Part. No.
280	230-270-310-350	40-23101

Colour: Light grey RAL 7035



Standard examples
see page 240

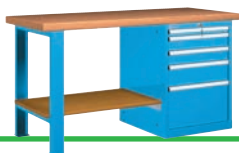

Series 40

Accessories for workbenches



Support columns

Made of high-quality steel. Supports included

Usable height mm	No. of panels required	Part. No.
327	1	40-90008
631	2	40-90016
935	3	40-90024
1239	4	40-90032

For workbench lengths 1250/1500/1750mm: 2 support columns

For workbench lengths 2000/2500/3000mm: 3 support columns

Colour: Light grey RAL 7035



For better stability of support columns it is necessary to install at least one perforated back panel.

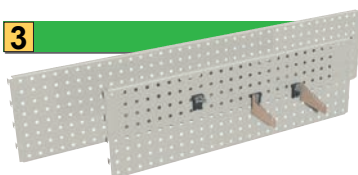

Perforated back panels

Made of high-quality steel

Worktop length mm	Width mm	Height mm	No. of panels required	Part. No.
1250	1198	304	1	40-91230
1500	1448	304	1	40-91530
1750	1698	304	1	40-91730
2000	968	304	2	40-91030
2500	1218	304	2	40-91330
3000	1468	304	2	40-91630

Colour: Light grey RAL 7035



Adjustable shelves

Made of high-quality steel. Supports included

Worktop length mm	Usable width mm	Usable depth mm	Load capacity kg	No. of shelves required	Part. No.
1250	1196	320	50	1	40-92232
1500	1446	320	50	1	40-92532
1750	1696	320	50	1	40-92732
2000	966	320	50	2	40-92032
2500	1216	320	50	2	40-92332
3000	1466	320	50	2	40-92632

Incline: 0° / 8° / 15°

Colour: Light grey RAL 7035



Hooks see page 249

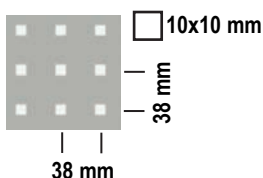

Standard colour:
RAL 7035



Load capacity is intended for evenly distributed loads

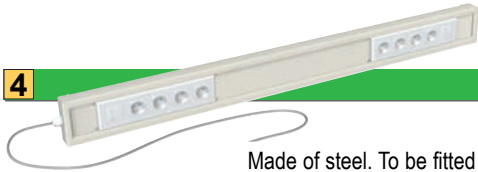

4 **Power trunking**

Made of steel. To be fitted to the perforated panel
With 1m connecting cable

Worktop length mm	Width mm	Depth mm	Height mm	Socket type	Socket type
				Schuko Part. No.	UK Part. No.
1500	1420	55	160	40-06150	40-06156
2000	1920	55	160	40-06200	40-06206

With 6 sockets and on/off switch

Different types of sockets are available on request

Colour: Light grey RAL 7035

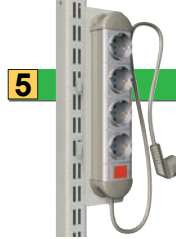

5 **Socket block**

To be fitted to the support column
With 1m connecting cable

Socket type	Socket type
40-06010	40-06016

Metal support included

With 4 sockets and on/off switch

Different types of sockets are available on request

Colour: Light grey RAL 7035

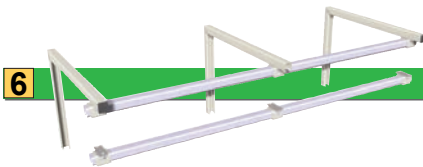

6 **Slide-track**

Made of steel
To be fitted to the support columns

Worktop length mm	Depth mm	Height mm	Load capacity kg	Rail with supports Part. No.	Additional rail Part. No.
1250	660	300	20	40-95112	40-95012
1500	660	300	20	40-95115	40-95015
1750	660	300	20	40-95117	40-95017
2000	660	300	20	40-95120	40-95020
2500	660	300	20	40-95125	40-95025
3000	660	300	20	40-95130	40-95030

Colour: Supports in Light grey RAL 7035, rail in galvanised steel



7 **Overhead light**

To be fitted to rail

Size mm	Protection	Watt	Light only Part. No.
1000x100x50 mm	IP 66	2x36 W	46-09002

Power cable not supplied



Slider
Made of steel. For rail

Part. No.
40-95001

Load capacity: 3kg



Standard examples
see page 246

Standard colour:
RAL 7035



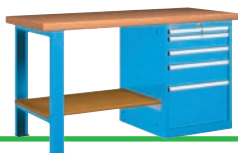

Series 40

Standard examples:

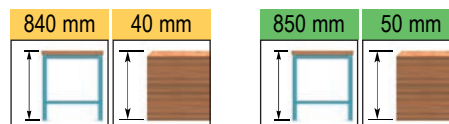

- Fittings:
- 1 Worktop
 - 2 Legs 800mmh
 - 2 Pre-assembled kits

Length mm	Depth mm	Thickness mm	Multiplex	MDF	Plastic laminated
1250	750	40	44-80127-001	44-80127-101	-
1500	750	40	44-80157-001	44-80157-101	44-80157-201
2000	750	40	44-80207-001	44-80207-101	44-80207-201
1250	750	50	45-80127-001	45-80127-101	-
1500	750	50	45-80157-001	45-80157-101	-
2000	750	50	45-80207-001	45-80207-101	-

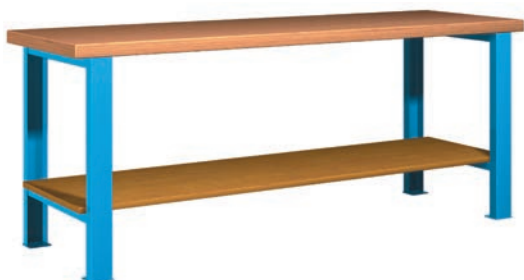

- Fittings:
- 1 Worktop
 - 2/3 Legs 800mmh
 - 1 Underslung shelf
 - 2/3 Pre-assembled kits
- ** with 3 legs

Length mm	Depth mm	Thickness mm	Multiplex	MDF	Plastic laminated
1250	750	40	44-80127-002	44-80127-102	-
1500	750	40	44-80157-002	44-80157-102	44-80157-202
2000	750	40	44-80207-002	44-80207-102	44-80207-202
2500	750	40	44-80257-002**	44-80257-102**	44-80257-202*
1250	750	50	45-80127-002	45-80127-102	-
1500	750	50	45-80157-002	45-80157-102	-
2000	750	50	45-80207-002	45-80207-102	-
2500	750	50	45-80257-002	45-80257-102	-

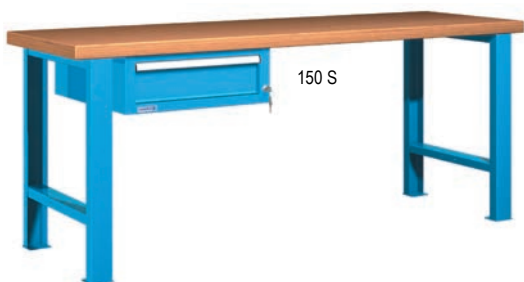

- Fittings:
- 1 Worktop
 - 2 Legs 800mmh
 - 1 Workbench drawer
 - 3 Pre-assembled kits

Length mm	Depth mm	Thickness mm	Multiplex	MDF	Plastic laminated
1500	750	40	44-80157-003	44-80157-103	44-80157-203
2000	750	40	44-80207-003	44-80207-103	44-80207-203
1500	750	50	45-80157-003	45-80157-103	-
2000	750	50	45-80207-003	45-80207-103	-

Standard colours:

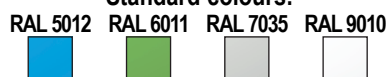

Standard examples:

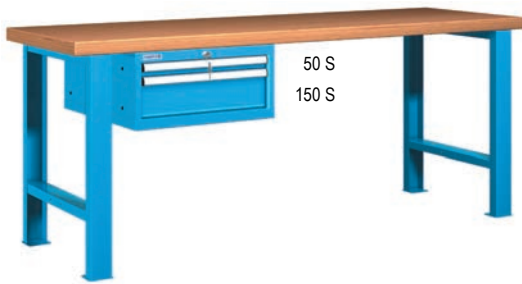

50 S
150 S

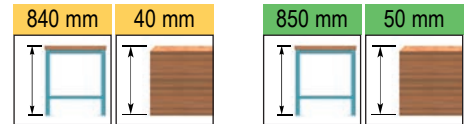

- Fittings:
- 1 Worktop
 - 2 Legs 800mmh
 - 1 Cabinet 27x36 Eh 283mmh with 2 drawers
 - 3 Pre-assembled kits

Length mm	Depth mm	Thickness mm	Multiplex	MDF	Plastic laminated
1500	750	40	44-80157-004	44-80157-104	44-80157-204
2000	750	40	44-80207-004	44-80207-104	44-80207-204
1500	750	50	45-80157-004	45-80157-104	-
2000	750	50	45-80207-004	45-80207-104	-

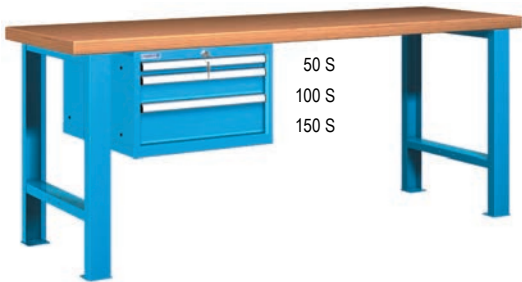

50 S
100 S
150 S

- Fittings:
- 1 Worktop
 - 2 Legs 800mmh
 - 1 Cabinet 27x36 Eh 383mmh with 3 drawers
 - 3 Pre-assembled kits

Length mm	Depth mm	Thickness mm	Multiplex	MDF	Plastic laminated
1500	750	40	44-80157-005	44-80157-105	44-80157-205
2000	750	40	44-80207-005	44-80207-105	44-80207-205
1500	750	50	45-80157-005	45-80157-105	-
2000	750	50	45-80207-005	45-80207-105	-

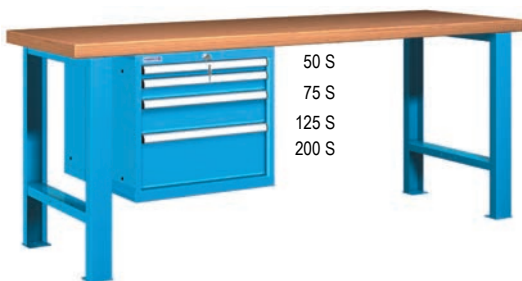





50 S
75 S
125 S
200 S

- Fittings:
- 1 Worktop
 - 2 Legs 800mmh
 - 1 Cabinet 27x36 Eh 533mmh with 4 drawers
 - 3 Pre-assembled kits

Length mm	Depth mm	Thickness mm	Multiplex	MDF	Plastic laminated
1500	750	40	44-80157-006	44-80157-106	44-80157-206
2000	750	40	44-80207-006	44-80207-106	44-80207-206
1500	750	50	45-80157-006	45-80157-106	-
2000	750	50	45-80207-006	45-80207-106	-



Partitioning material
see page 30

Standard colours:
 RAL 5012  RAL 6011  RAL 7035  RAL 9010 

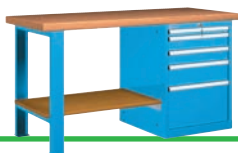

Series 40

Standard examples:

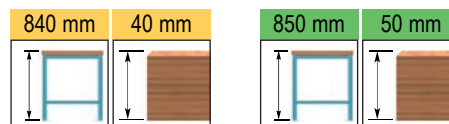

50 S
100 S
100 S
150 S
300 S

- Fittings:
- 1 Worktop
 - 1 Leg 800mmh
 - 1 Cabinet 27x36 Eh 800mmh with 5 drawers
 - 2 Pre-assembled kits

Length mm	Depth mm	Thickness mm	Multiplex	MDF	Plastic laminated
1500	750	40	44-80157-007	44-80157-107	44-80157-207
2000	750	40	44-80207-007	44-80207-107	44-80207-207
1500	750	50	45-80157-007	45-80157-107	-
2000	750	50	45-80207-007	45-80207-107	-

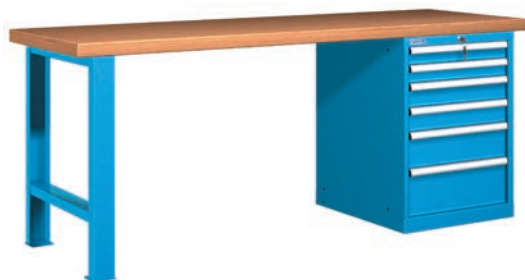

75 S
75 S
100 S
100 S
150 S
200 S

- Fittings:
- 1 Worktop
 - 1 Leg 800mmh
 - 1 Cabinet 27x36 Eh 800mmh with 6 drawers
 - 2 Pre-assembled kits

Length mm	Depth mm	Thickness mm	Multiplex	MDF	Plastic laminated
1500	750	40	44-80157-008	44-80157-108	44-80157-208
2000	750	40	44-80207-008	44-80207-108	44-80207-208
1500	750	50	45-80157-008	45-80157-108	-
2000	750	50	45-80207-008	45-80207-108	-

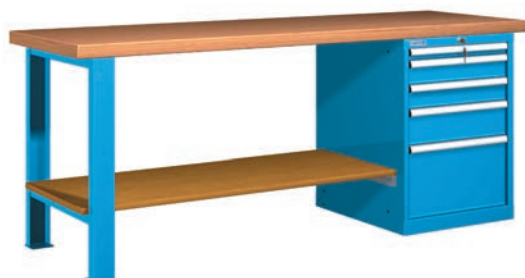

50 S
100 S
100 S
150 S
300 S

- Fittings:
- 1 Worktop
 - 1 Leg 800mmh
 - 1 Cabinet 27x36 Eh 800mmh with 5 drawers
 - 1 Underslung shelf and support bracket
 - 2 Pre-assembled kits

Length mm	Depth mm	Thickness mm	Multiplex	MDF	Plastic laminated
1500	750	40	44-80157-019	44-80157-119	44-80157-219
2000	750	40	44-80207-019	44-80207-119	44-80207-219
1500	750	50	45-80157-019	45-80157-119	-
2000	750	50	45-80207-019	45-80207-119	-

Standard colours:

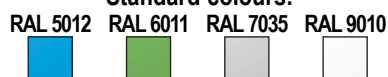

Standard examples:

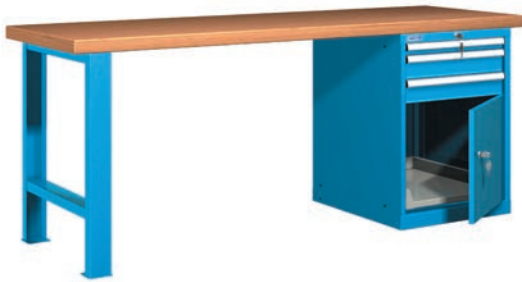

50 S
100 S
100 S

Fittings:

1 Worktop
1 Leg 800mmh

AS S 1 Cabinet 27x36 Eh 800mmh with 3 drawers, 1 adjustable shelf and 1 door
2 Pre-assembled kits

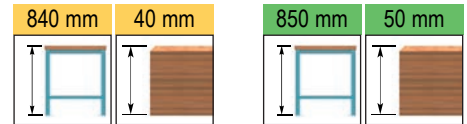

Length mm	Depth mm	Thickness mm	Multiplex	MDF	Plastic laminated
1500	750	40	44-80157-010	44-80157-110	44-80157-210
2000	750	40	44-80207-010	44-80207-110	44-80207-210
1500	750	50	45-80157-010	45-80157-110	-
2000	750	50	45-80207-010	45-80207-110	-

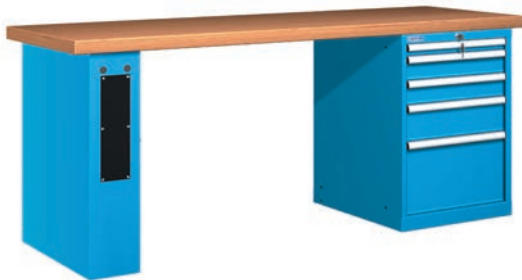

50 S
100 S
100 S
150 S
300 S

Fittings:

1 Worktop
1 Service leg 800mmh
1 Cabinet 27x36 Eh 800mmh with 5 drawers
2 Pre-assembled kits

Length mm	Depth mm	Thickness mm	Multiplex	MDF	Plastic laminated
1500	750	40	44-80157-011	44-80157-111	44-80157-211
2000	750	40	44-80207-011	44-80207-111	44-80207-211
2500	750	40	44-80257-011	44-80257-111	44-80257-211
1500	750	50	45-80157-011	45-80157-111	-
2000	750	50	45-80207-011	45-80207-111	-
2500	750	50	45-80257-011	45-80257-111	-

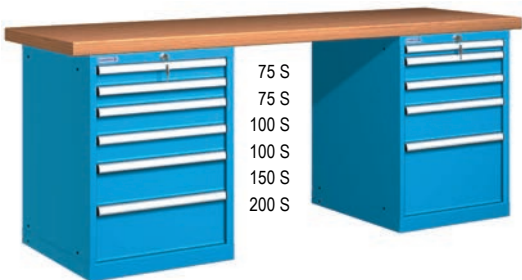

50 S
100 S
100 S
100 S
150 S
300 S

Fittings:





1 Worktop
1 Cabinet 27x36 Eh 800mmh with 6 drawers
1 Cabinet 27x36 Eh 800mmh with 5 drawers
2 Pre-assembled kits

Length mm	Depth mm	Thickness mm	Multiplex	MDF	Plastic laminated
2000	750	40	44-80207-012	44-80207-112	44-80207-212
2500	750	40	44-80257-012	44-80257-112	44-80257-212
2000	750	50	45-80207-012	45-80207-112	-
2500	750	50	45-80257-012	45-80257-112	-



Partitioning material
see page 30

Standard colours:

RAL 5012  RAL 6011  RAL 7035  RAL 9010 

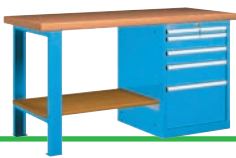

Series 40

Standard examples:

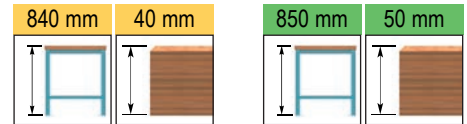

75 S
75 S
100 S
100 S
150 S
200 S

100 S

AS

RS S

Fittings:

- 1 Worktop
- 1 Cabinet 27x36 Eh 800mmh with 6 drawers
- 1 Cabinet 27x36 Eh 800mmh with 1 drawer, 1 adjustable shelf, 1 retractable shelf and 1 door
- 2 Pre-assembled kits

Length mm	Depth mm	Thickness mm	Multiplex	MDF	Plastic laminated
2000	750	40	44-80207-013	44-80207-113	44-80207-213
2500	750	40	44-80257-013	44-80257-113	44-80257-213
2000	750	50	45-80207-013	45-80207-113	-
2500	750	50	45-80257-013	45-80257-113	-

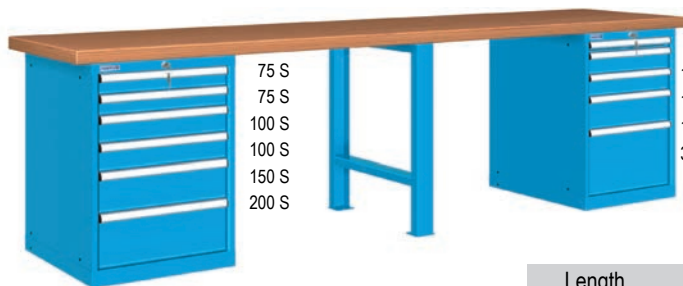

75 S
75 S
100 S
100 S
150 S
200 S

50 S
100 S
100 S
150 S
300 S

Fittings:

- 1 Worktop
- 1 Cabinet 27x36 Eh 800mmh with 6 drawers
- 1 Leg 800mmh
- 1 Cabinet 27x36 Eh 800mmh with 5 drawers
- 3 Pre-assembled kits

Length mm	Depth mm	Thickness mm	Multiplex	MDF	Plastic laminated
3000	750	40	44-80307-014*	44-80307-114	44-80307-214
3000	750	50	45-80307-014*	45-80307-114	-

* Multiplex worktop: 2x1500mm



75 S
75 S
100 S
100 S
150 S
200 S

50 S
100 S
100 S
150 S
300 S

Fittings:

- 1 Worktop
- AS 1 Cabinet 27x36 Eh 800mmh with 6 drawers
- 1 Cabinet 27x36 Eh 800mmh with 5 drawers
- RS S 1 Cabinet 27x36 Eh 800mmh with 1 drawer, 1 adjustable shelf, 1 retractable shelf and 1 door
- 3 Pre-assembled kits

Length mm	Depth mm	Thickness mm	Multiplex	MDF	Plastic laminated
3000	750	40	44-80307-015*	44-80307-115	44-80307-215
3000	750	50	45-80307-015*	45-80307-115	-

* Multiplex worktop: 2x1500mm

Standard colours:

RAL 5012 RAL 6011 RAL 7035 RAL 9010



Standard examples:

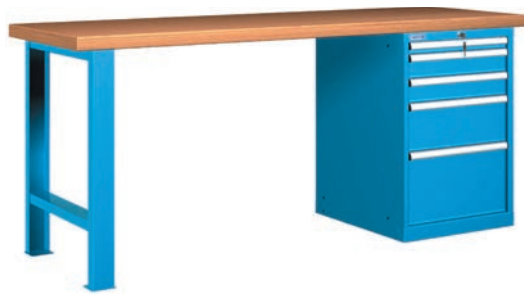

50 S
100 S
100 S
200 S
300 S

Fittings:

- 1 Worktop
- 1 Leg 850mmh
- 1 Cabinet 27x36 Eh 850mmh with 5 drawers
- 2 Pre-assembled kits

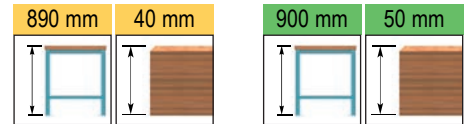

Length mm	Depth mm	Thickness mm	Multiplex	MDF	Plastic laminated
1500	750	40	44-85157-007	44-85157-107	44-85157-207
2000	750	40	44-85207-007	44-85207-107	44-85207-207
1500	750	50	45-85157-007	45-85157-107	-
2000	750	50	45-85207-007	45-85207-107	-



50 S
100 S
100 S
200 S
300 S

Fittings:

- 1 Worktop
- 1 Service leg 850mmh
- 1 Cabinet 27x36 Eh 850mmh with 5 drawers
- 2 Pre-assembled kits

Length mm	Depth mm	Thickness mm	Multiplex	MDF	Plastic laminated
1500	750	40	44-85157-011	44-85157-111	44-85157-211
2000	750	40	44-85207-011	44-85207-111	44-85207-211
2500	750	40	44-85257-011	44-85257-111	44-85257-211
1500	750	50	45-85157-011	45-85157-111	-
2000	750	50	45-85207-011	45-85207-111	-
2500	750	50	45-85257-011	45-85257-111	-



50 S
100 S
100 S
100 S
200 S
300 S

Fittings:





- 1 Worktop
- 1 Cabinet 27x36 Eh 850mmh with 6 drawers
- 1 Cabinet 27x36 Eh 850mmh with 5 drawers
- 2 Pre-assembled kits

Length mm	Depth mm	Thickness mm	Multiplex	MDF	Plastic laminated
2000	750	40	44-85207-012	44-85207-112	44-85207-212
2500	750	40	44-85257-012	44-85257-112	44-85257-212
2000	750	50	45-85207-012	45-85207-112	-
2500	750	50	45-85257-012	45-85257-112	-



Partitioning material
see page 30

Standard colours:

RAL 5012  RAL 6011  RAL 7035  RAL 9010 

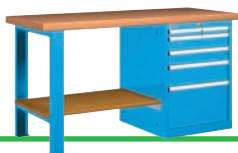

Series 40

Standard examples:



Workbench length	Workbench length	Workbench length
1250 mm	1500 mm	1750 mm
Part. No.	Part. No.	Part. No.
49-12101	49-15101	49-17101

1 Perforated back panel



Workbench length	Workbench length	Workbench length
1250 mm	1500 mm	1750 mm
Part. No.	Part. No.	Part. No.
49-12102	49-15102	49-17102

1 Perforated back panel and 1 shelf



Workbench length	Workbench length	Workbench length
2000 mm	2500 mm	3000 mm
Part. No.	Part. No.	Part. No.
49-20101	49-25101	49-30101

2 Perforated back panels



Workbench length	Workbench length	Workbench length
2000 mm	2500 mm	3000 mm
Part. No.	Part. No.	Part. No.
49-20102	49-25102	49-30102

2 Perforated back panels and 1 shelf



Workbench length	Workbench length	Workbench length
2000 mm	2500 mm	3000 mm
Part. No.	Part. No.	Part. No.
49-20103	49-25103	49-30103

2 Perforated back panels and 2 shelves

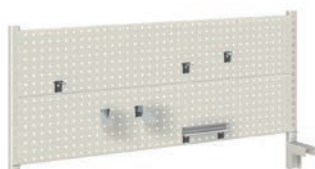

Workbench length	Workbench length	Workbench length
1250 mm	1500 mm	1750 mm
Part. No.	Part. No.	Part. No.
49-12201	49-15201	49-17201

2 Perforated back panels



Workbench length	Workbench length	Workbench length
1250 mm	1500 mm	1750 mm
Part. No.	Part. No.	Part. No.
49-12202	49-15202	49-17202

1 Perforated back panel and 1 shelf



Workbench length	Workbench length	Workbench length
1250 mm	1500 mm	1750 mm
Part. No.	Part. No.	Part. No.
49-12203	49-15203	49-17203

1 Perforated back panel and 2 shelves



Workbench length	Workbench length	Workbench length
1250 mm	1500 mm	1750 mm
Part. No.	Part. No.	Part. No.
49-12204	49-15204	49-17204

2 Perforated back panels and 1 shelf

Standard colour:

RAL 7035



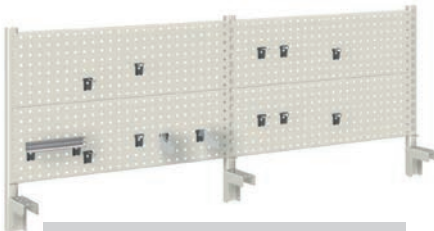

Workbench length	Workbench length	Workbench length
2000 mm	2500 mm	3000 mm
Part. No.	Part. No.	Part. No.
49-20201	49-25201	49-30201

4 Perforated back panels



Workbench length	Workbench length	Workbench length
2000 mm	2500 mm	3000 mm
Part. No.	Part. No.	Part. No.
49-20202	49-25202	49-30202

3 Perforated back panels and 2 shelves



Workbench length	Workbench length	Workbench length
2000 mm	2500 mm	3000 mm
Part. No.	Part. No.	Part. No.
49-20203	49-25203	49-30203

2 Perforated back panels and 2 shelves



Workbench length	Workbench length	Workbench length
2000 mm	2500 mm	3000 mm
Part. No.	Part. No.	Part. No.
49-20204	49-25204	49-30204

2 Perforated back panels and 4 shelves

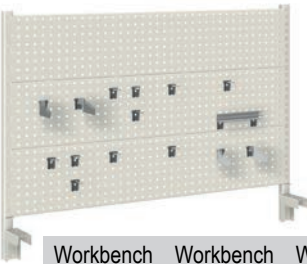

Workbench length	Workbench length	Workbench length
1250 mm	1500 mm	1750 mm
Part. No.	Part. No.	Part. No.
49-12301	49-15301	49-17301

3 Perforated back panels

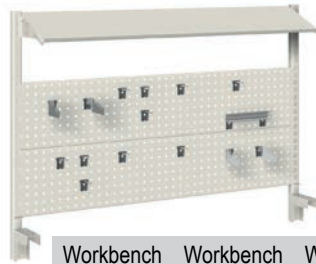

Workbench length	Workbench length	Workbench length
1250 mm	1500 mm	1750 mm
Part. No.	Part. No.	Part. No.
49-12302	49-15302	49-17302

2 Perforated back panels and 1 shelf

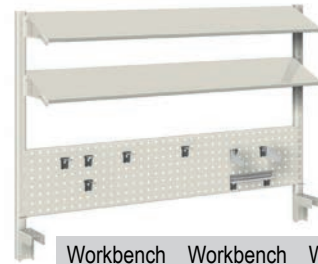

Workbench length	Workbench length	Workbench length
1250 mm	1500 mm	1750 mm
Part. No.	Part. No.	Part. No.
49-12303	49-15303	49-17303

1 Perforated back panel and 2 shelves

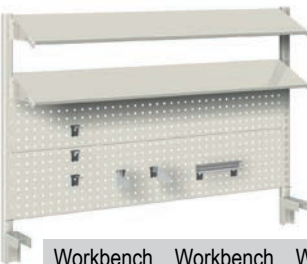

Workbench length	Workbench length	Workbench length
1250 mm	1500 mm	1750 mm
Part. No.	Part. No.	Part. No.
49-12304	49-15304	49-17304

2 Perforated back panels and 2 shelves



Workbench length	Workbench length	Workbench length
1250 mm	1500 mm	1750 mm
Part. No.	Part. No.	Part. No.
49-12305	49-15305	49-17305

1 Perforated back panel and 3 shelves

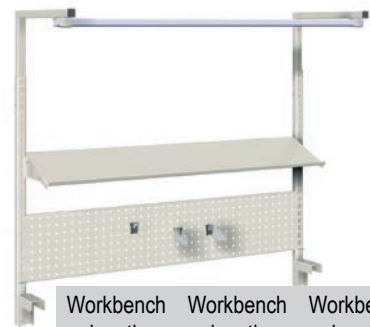

Workbench length	Workbench length	Workbench length
1250 mm	1500 mm	1750 mm
Part. No.	Part. No.	Part. No.
49-12306	49-15306	49-17306

1 Perforated back panel, 1 shelf and 1 rail



Standard examples are not supplied with hooks

Standard colour:

RAL 7035



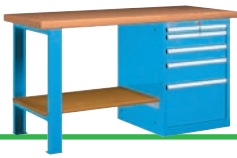

Series 40

Standard examples:

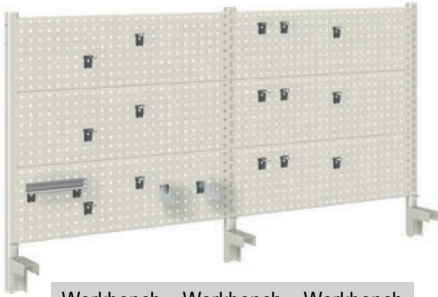

Workbench length	Workbench length	Workbench length
2000 mm	2500 mm	3000 mm
Part. No.	Part. No.	Part. No.
49-20301	49-25301	49-30301

6 Perforated back panels



Workbench length	Workbench length	Workbench length
2000 mm	2500 mm	3000 mm
Part. No.	Part. No.	Part. No.
49-20302	49-25302	49-30302

4 Perforated back panels and 2 shelves



Workbench length	Workbench length	Workbench length
2000 mm	2500 mm	3000 mm
Part. No.	Part. No.	Part. No.
49-20303	49-25303	49-30303

2 Perforated back panels and 4 shelves



Workbench length	Workbench length	Workbench length
2000 mm	2500 mm	3000 mm
Part. No.	Part. No.	Part. No.
49-20306	49-25306	49-30306

2 Perforated back panels, 2 shelves and 1 rail

Standard colour:

RAL 7035



Standard examples are not supplied with hooks



Standard examples will require assembly

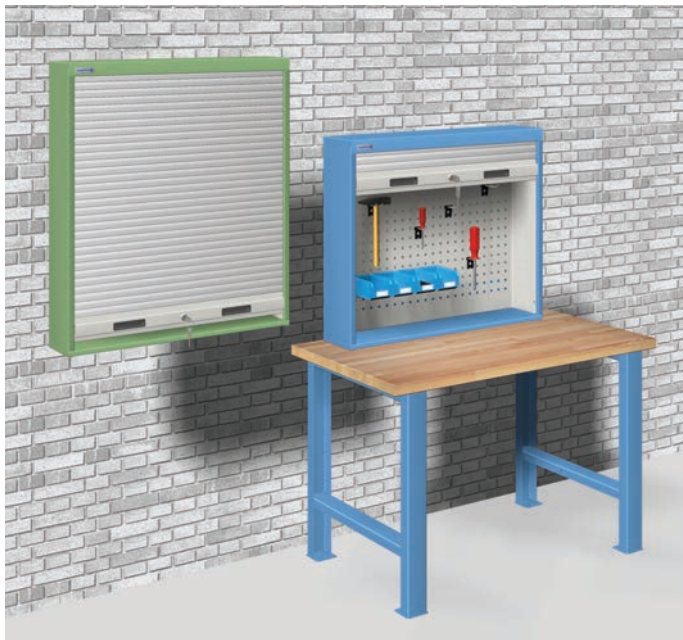

Hooks

to be fitted onto perforated panels



Hook type	Length mm	Part. No.
1	40	06-70040
2	100	06-70100



Hook type	Length mm	Part. No.
3	40	06-71055
4	100	06-71100



Hook type	Ø mm	Part. No.
1	6	06-71406
2	10	06-71410
3	14	06-71414



Hook type	Width mm	Part. No.
1	27,5	06-71728
2	34,5	06-71735
3	41,5	06-71742



Roller shutter cabinets

Made of high-quality sheet steel, painted with high resistance products, environmentally friendly. Complete with perforated back panel in Light grey RAL 7035 and safety cylinder lock and 2 keys. To be secured to the wall or workbench.

Width mm	Depth mm	Height mm	Part. No.
952	210	810	40-91008
952	210	1114	40-91010

Load capacity: 50kg

Colours: see colour chart at the bottom of the page

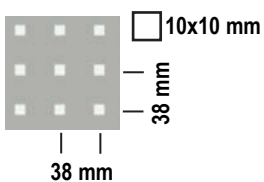

Standard colours:

RAL 5012	RAL 6011	RAL 7035	RAL 9010

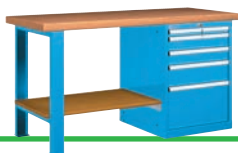

Series 40

Wall panels - perforated

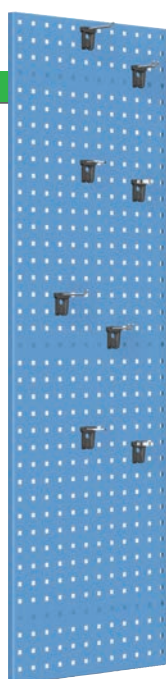
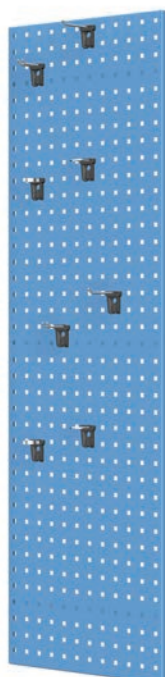
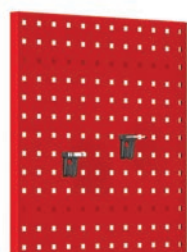

Perforated panels

Made of high-quality steel.
To be fixed to the wall

Width mm	Height mm	Depth mm	Part. No.
456	500	22	06-45050
456	1000	22	06-45100
456	1500	22	06-45150

Colours: see colour chart at the bottom of the page

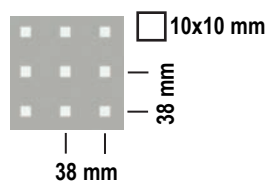

Hooks

to be fitted onto perforated panels



Hook type	Length mm	Part. No.
1	40	06-70040
2	100	06-70100



Hook type	Length mm	Part. No.
3	40	06-71055
4	100	06-71100



Hook type	Ø mm	Part. No.
1	6	06-71406
2	10	06-71410
3	14	06-71414



Hook type	Width mm	Part. No.
1	27,5	06-71728
2	34,5	06-71735
3	41,5	06-71742

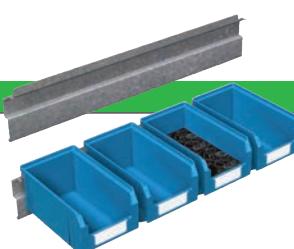

Rails for plastic containers

Made of high-quality steel.
To be clipped onto the perforated panels

Height mm	Width mm	Part. No.
80	445	06-72204

Containers **Size 1**: 4 per rail
Containers **Size 2**: 3 per rail



Plastic containers

see page 327

Standard colours:

RAL 5012 RAL 6011 RAL 7035 RAL 9010





Power tower

Made of high-quality sheet steel.
Complete with wooden top.

Size:	Part. No.
905x788x298 mm H	40-00612
without covers or socket blocks	
Colour: Light grey RAL 7035	



Hexagonal worktops

Consists of 2 pieces.
Complete with connecting parts.

Worktop type	Thickness 40 mm	Thickness 50 mm
Multiplex	40-40612	40-50612
Plastic laminated	40-48617	-
Plastic laminated: Light grey		

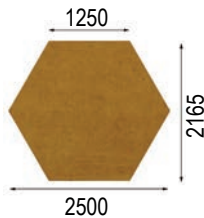

Socket blocks

Power cable not supplied
230 V = socket type Schuko - 380 V = 3P+T

	Part. No.
without holes	40-00710



Fittings:	Part. No.
1x230 V	40-00711



Fittings:	Part. No.
2x230 V	40-00712



Fittings:	Part. No.
1x230 V + 1 air system	40-00713



Fittings:	Part. No.
1x380 V	40-00714



Fittings:	Part. No.
2x380 V	40-00715



Fittings:	Part. No.
mit 1x380 V + 1 air system	40-00716



Fittings:	Part. No.
1x230 V + 1x380 V	40-00717



Fittings:	Part. No.
1x230 V + 1x380 V + 1 air system	40-00718



Cabinet housings

see page 235

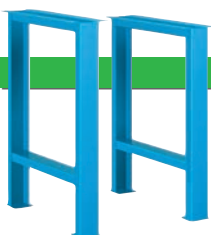

Workbench legs

see page 234

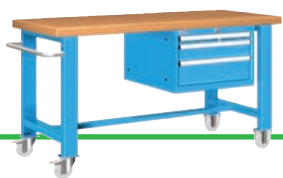

Series 40

Components for mobile workbenches



Legs

with handle

Load capacity	Part. No.
kg 400	40-68005

Size: 725x80x800 mm



Legs

with swivel braked castors and handle

Wheel	Load capacity	Part. No.
Ø 100 mm	kg	
polyurethane	200	40-68014
nylon	200	40-68020

Size: 725x80x800 mm



Legs

with fixed castors

Wheel	Load capacity	Part. No.
Ø 100 mm	kg	
polyurethane	200	40-68010
nylon	200	40-68016

Size: 725x80x800 mm



Adjustable legs

with fixed castors

Wheel	Load capacity	Part. No.
Ø 100 mm	kg	
polyurethane	200	40-69010
nylon	200	40-69016

Size: 725x80x800/1100 mm ; slotted 25 mm



Legs

with swivel braked castors

Wheel	Load capacity	Part. No.
Ø 100 mm	kg	
polyurethane	200	40-68012
nylon	200	40-68018

Size: 725x80x800 mm



Adjustable legs

with swivel braked castors

Wheel	Load capacity	Part. No.
Ø 100 mm	kg	
polyurethane	200	40-69022
nylon	200	40-69018

Size: 725x80x800 mm /1100 mm ; slotted 25 mm

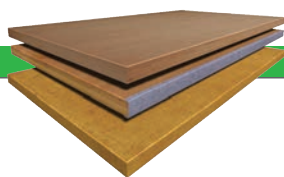

Worktops

see page 208



Connection bars

Made of high-quality steel. To stabilise the workbench when legs with castors are used.



Fixing material

for legs and power legs

	Part. No.
Pre-assembled kit (for legs)	40-00012
Fixing hardware kit (for legs)	40-00013
6 bolts M10 and 6 threaded inserts for wood M10	

Worktop length	Connection bar length	Part. No.
mm	mm	
1250	974	40-70012
1500	1224	40-70015
1750	1474	40-70017
2000	1724	40-70020

Colours: see colour chart at the bottom of the page

Standard colours:

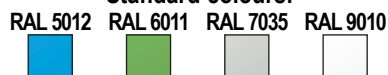

nylon castors



polyurethane castors



Load capacity is intended for evenly distributed loads

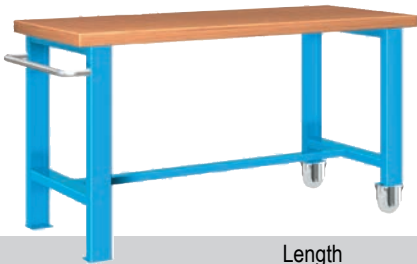

Depth mm	Height mm	Length 1250 mm Part. No.	Length 1500 mm Part. No.	Length 2000 mm Part. No.
750	840	43-84127-31	43-84157-31	43-84207-31

Fittings:

- 1 Worktop in Multiplex 40 mm thick
- 1 Leg with handle
- 1 Leg with fixed nylon castors, Ø 100 mm
- 1 Connection bar - 2 pre-assembled kits

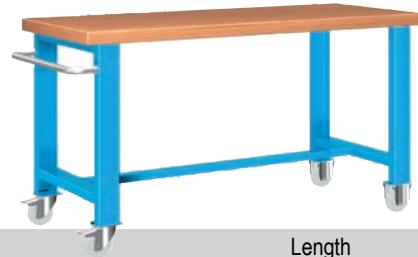

Depth mm	Height mm	Length 1250 mm Part. No.	Length 1500 mm Part. No.	Length 2000 mm Part. No.
750	840	43-84127-41	43-84157-41	43-84207-41

Fittings:

- 1 Worktop in Multiplex 40 mm thick
- 1 Leg with swivel braked nylon castors, Ø 100 mm and handle
- 1 Leg with fixed nylon castors, Ø 100 mm
- 1 Connection bar - 2 pre-assembled kits



150 S

Depth mm	Height mm	Length 1250 mm Part. No.	Length 1500 mm Part. No.	Length 2000 mm Part. No.
750	840	43-84127-32	43-84157-32	43-84207-32

Fittings:

- 1 Worktop in Multiplex 40 mm thick
- 1 Leg with handle
- 1 Leg with fixed nylon castors, Ø 100 mm
- 1 Workbench drawer 27x36 Eh
- 1 Connection bar - 3 pre-assembled kits



150 S

Depth mm	Height mm	Length 1250 mm Part. No.	Length 1500 mm Part. No.	Length 2000 mm Part. No.
750	840	43-84127-42	43-84157-42	43-84207-42

Fittings:

- 1 Worktop in Multiplex 40 mm thick
- 1 Leg with swivel braked nylon castors, Ø 100 mm and handle
- 1 Leg with fixed nylon castors, Ø 100 mm
- 1 Workbench drawer 27x36 Eh
- 1 Connection bar - 3 pre-assembled kits

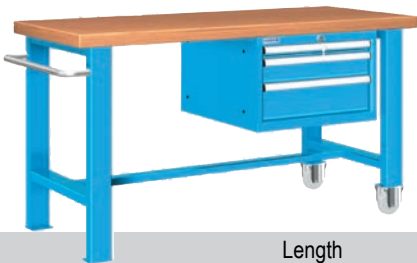

50 S
100 S
150 S

Depth mm	Height mm	Length 1250 mm Part. No.	Length 1500 mm Part. No.	Length 2000 mm Part. No.
750	840	43-84127-33	43-84157-33	43-84207-33

Fittings:

- 1 Worktop in Multiplex 40 mm thick
- 1 Leg with handle
- 1 Leg with fixed nylon castors, Ø 100 mm
- 1 Cabinet 27x36 Eh 383mmh with 3 drawers
- 1 Connection bar - 3 pre-assembled kits

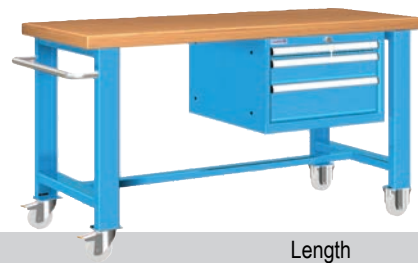

50 S
100 S
150 S

Depth mm	Height mm	Length 1250 mm Part. No.	Length 1500 mm Part. No.	Length 2000 mm Part. No.
750	840	43-84127-43	43-84157-43	43-84207-43





Fittings:

- 1 Worktop in Multiplex 40 mm thick
- 1 Leg with swivel braked nylon castors, Ø 100 mm and handle
- 1 Leg with fixed nylon castors, Ø 100 mm
- 1 Cabinet 27x36 Eh 383mmh with 3 drawers
- 1 Connection bar - 3 pre-assembled kits



Standard examples are equipped with nylon castors, Ø 100 mm

Standard colours:

RAL 5012	RAL 6011	RAL 7035	RAL 9010
			



Series 42

1500x750 mm

MODULAR workbench

Made of high-quality sheet steel. Housing sides and bases are welded and painted with high resistance products, environmentally friendly. Available in 2 lengths: 1500 and 2000 mm with multiplex or MDF top. Fitted with safety cylinder lock with 2 keys.



Width mm	Depth mm	Height mm	Multiplex Part. No.	MDF Part. No.
1500	750	840	42-84157-001	42-84157-101

Fittings:

- 1 Worktop 40mmh
- 1 Drawer 27x36 Eh
- 1 Door 450mmh
- 1 Adjustable shelf

Colour: frame Light grey RAL 7035 – accessories: see colour chart



Width mm	Depth mm	Height mm	Multiplex Part. No.	MDF Part. No.
1500	750	840	42-84157-002	42-84157-102

Fittings:

- 1 Worktop 40mmh
- 2 Drawers 27x36 Eh
- 2 Doors 450mmh

Colour: frame Light grey RAL 7035 – accessories: see colour chart



Width mm	Depth mm	Height mm	Multiplex Part. No.	MDF Part. No.
1500	750	840	42-84157-003	42-84157-103

Fittings:

- 1 Worktop 40mmh
- 3 Drawers 27x36 Eh
- 1 Adjustable shelf

Colour: frame Light grey RAL 7035 – accessories: see colour chart



Width mm	Depth mm	Height mm	Multiplex Part. No.	MDF Part. No.
1500	750	840	42-84157-004	42-84157-104

Fittings:

- 1 Worktop 40mmh
- 4 Drawers 27x36 Eh
- 1 Adjustable shelf

Colour: frame Light grey RAL 7035 – accessories: see colour chart

Standard colours:

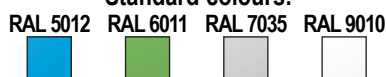

Standard examples:



Width mm	Depth mm	Height mm	Multiplex Part. No.	MDF Part. No.
1500	750	840	42-84157-005	42-84157-105

Fittings:

1 Worktop 40mmh

6 Drawers 27x36 Eh

Colour: frame Light grey RAL 7035 – accessories: see colour chart



Width mm	Depth mm	Height mm	Multiplex Part. No.	MDF Part. No.
1500	750	840	42-84157-006	42-84157-106

Fittings:

1 Worktop 40mmh

8 Drawers 27x36 Eh

Colour: frame Light grey RAL 7035 – accessories: see colour chart



Width mm	Depth mm	Height mm	Multiplex Part. No.	MDF Part. No.
1500	750	840	42-84157-007	42-84157-107

Fittings:

1 Worktop 40mmh

4 Drawers 27x36 Eh

1 Door 600mmh

1 Adjustable shelf

Colour: frame Light grey RAL 7035 – accessories: see colour chart

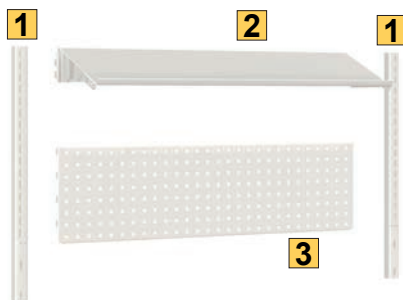

1 Support columns

Usable height mm	No. of panels required	Part. No.
327	1	42-90008
631	2	42-90016
935	3	42-90024

Colour: Light grey RAL 7035

2 Adjustable shelf

Width mm	Usable depth mm	Part. No.
1056	320	42-92032

Colour: Light grey RAL 7035

3 Perforated panel

Width mm	Height mm	Part. No.
1056	304	42-91030

Colour: Light grey RAL 7035



Hooks
see page 249



Partitioning material
see page 259

Standard colours:

RAL 5012	RAL 6011	RAL 7035	RAL 9010



Series 42

2000x750 mm

MODULAR workbench



Width mm	Depth mm	Height mm	Multiplex Part. No.	MDF Part. No.
2000	750	840	42-84207-001	42-84207-101

Fittings:

- 1 Worktop 40mmh
- 2 Drawers 27x36 Eh
- 2 Doors 450mmh
- 1 Adjustable shelf

Colour: frame Light grey RAL 7035 – accessories: see colour chart

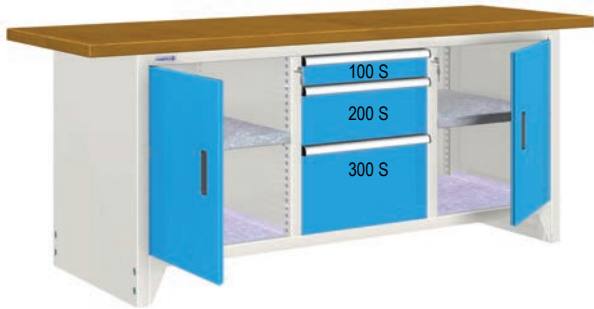

Width mm	Depth mm	Height mm	Multiplex Part. No.	MDF Part. No.
2000	750	840	42-84207-002	42-84207-102

Fittings:

- 1 Worktop 40mmh
- 3 Drawers 27x36 Eh
- 2 Doors 600mmh
- 2 Adjustable shelves

Colour: frame Light grey RAL 7035 – accessories: see colour chart

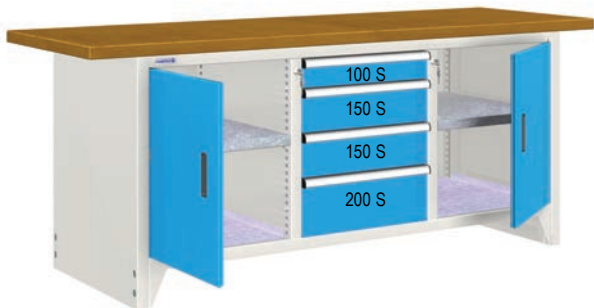

Width mm	Depth mm	Height mm	Multiplex Part. No.	MDF Part. No.
2000	750	840	42-84207-003	42-84207-103

Fittings:

- 1 Worktop 40mmh
- 4 Drawers 27x36 Eh
- 2 Doors 600mmh
- 2 Adjustable shelves

Colour: frame Light grey RAL 7035 – accessories: see colour chart



Width mm	Depth mm	Height mm	Multiplex Part. No.	MDF Part. No.
2000	750	840	42-84207-004	42-84207-104

Fittings:

- 1 Worktop 40mmh
- 6 Drawers 27x36 Eh
- 1 Adjustable shelf

Colour: frame Light grey RAL 7035 – accessories: see colour chart

Standard colours:

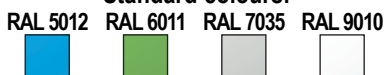

Standard examples:



Width mm	Depth mm	Height mm	Multiplex Part. No.	MDF Part. No.
2000	750	840	42-84207-005	42-84207-105

Fittings:

- 1 Worktop 40mmh
- 8 Drawers 27x36 Eh
- 1 Adjustable shelf

Colour: frame Light grey RAL 7035 – accessories: see colour chart



Width mm	Depth mm	Height mm	Multiplex Part. No.	MDF Part. No.
2000	750	840	42-84207-006	42-84207-106

Fittings:

- 1 Worktop 40mmh
- 4 Drawers 27x36 Eh
- 1 Door 450mmh
- 1 Adjustable shelf

Colour: frame Light grey RAL 7035 – accessories: see colour chart



Width mm	Depth mm	Height mm	Multiplex Part. No.	MDF Part. No.
2000	750	840	42-84207-007	42-84207-107

Fittings:

- 1 Worktop 40mmh
- 5 Drawers 27x36 Eh
- 1 Door 450mmh
- 1 Adjustable shelf

Colour: frame Light grey RAL 7035 – accessories: see colour chart

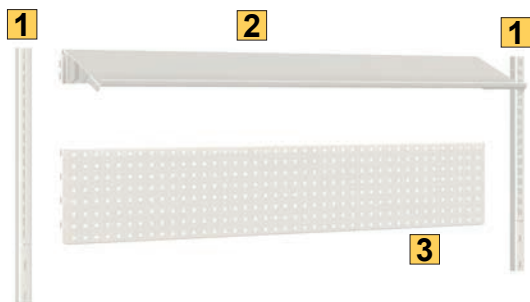

1 Support columns

Usable height mm	No. of panels required	Part. No.
327	1	42-90008
631	2	42-90016
935	3	42-90024

Colour: Light grey RAL 7035

2 Adjustable Shelf

Width mm	Usable depth mm	Part. No.
1604	320	42-92532

Colour: Light grey RAL 7035

3 Perforated panel

Width mm	Height mm	Part. No.
1604	304	42-91530

Colour: Light grey RAL 7035



Hooks
see page 249



Partitioning material
see page 259

Standard colours:

RAL 5012	RAL 6011	RAL 7035	RAL 9010



Series 47

MODULAR mobile workbench

Made of high-quality sheet steel. Housing sides and bases are welded and painted with high resistance products, environmentally friendly. Available in 2 lengths with worktop L.1000mm or L. 1250mm, in multiplex or MDF. Complete with handle and pair of polyurethane castors (2 swivel braked and 2 fixed) Ø 150 mm, safety cylinder lock and 2 keys.



100 S
150 S
150 S
200 S

Width mm	Depth mm	Height mm	Multiplex Part. No.	MDF Part. No.
1065	750	908	47-90020-002	47-90020-102

Fittings:

- 1 Worktop 40mmh
- 4 Drawers 27x36 Eh
- 1 Fixed shelf
- 2 Fixed and 2 swivel braked polyurethane castors, Ø 150 mm
- Colour: frame Light grey RAL 7035 – accessories: see colour chart



100 S
150 S
150 S
200 S

Width mm	Depth mm	Height mm	Multiplex Part. No.	MDF Part. No.
1315	750	908	47-90120-002	47-90120-102

Fittings:

- 1 Worktop 40mmh
- 4 Drawers 27x36 Eh
- 1 Fixed shelf
- 2 Fixed and 2 swivel braked polyurethane castors, Ø 150 mm
- Colour: frame Light grey RAL 7035 – accessories: see colour chart



100 S
150 S
150 S
150 S
200 S

Width mm	Depth mm	Height mm	Multiplex Part. No.	MDF Part. No.
1315	750	908	47-91120-004	47-91120-104

Fittings:

- 1 Worktop 40mmh
- 8 Drawers 27x36 Eh
- 2 Fixed and 2 swivel braked polyurethane castors, Ø 150 mm
- Colour: frame Light grey RAL 7035 – accessories: see colour chart



100 S
150 S
150 S
200 S

Width mm	Depth mm	Height mm	Multiplex Part. No.	MDF Part. No.
1315	750	908	47-91120-006	47-91120-106

Fittings:

- 1 Worktop 40mmh
- 4 Drawers 27x36 Eh
- 1 Door 600mmh
- 1 Adjustable shelf
- 2 Fixed and 2 swivel braked polyurethane castors, Ø 150 mm
- Colour: frame Light grey RAL 7035 – accessories: see colour chart

Standard colours:

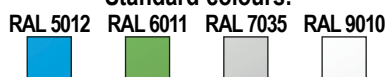

Standard examples are equipped with 2 fixed and 2 swivel braked polyurethane castors, Ø 150 mm



Standard examples are supplied assembled



Standard examples:

Partitioning material

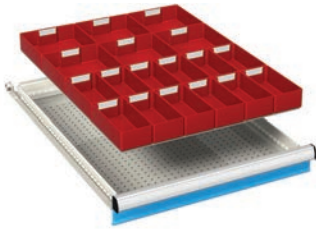

For front height:	Part. No.
100-125 mm	07-21410
12 Plastic boxes	150x75 mm
6 Plastic boxes	150x150 mm

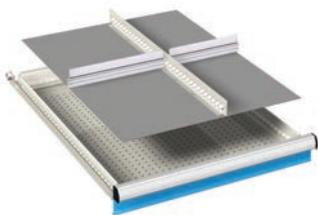

For front height:	Part. No.
100 mm	07-23010
150 mm	07-23015
200 mm	07-23020
1 Slotted partition	36 Eh
1 Aluminium divider	12 Eh
1 Aluminium divider	15 Eh

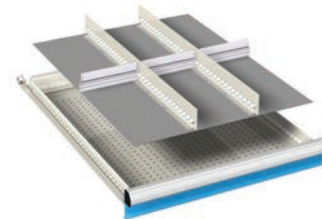

For front height:	Part. No.
100 mm	07-23110
150 mm	07-23115
200 mm	07-23120
2 Slotted partitions	36 Eh
3 Aluminium dividers	9 Eh

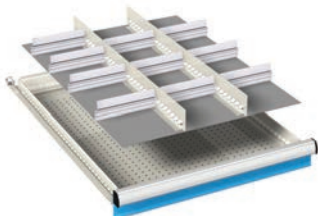

For front height:	Part. No.
100 mm	07-23210
150 mm	07-23215
2 Slotted partitions	36 Eh
10 Aluminium dividers	9 Eh

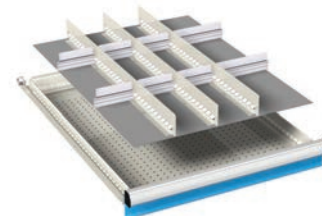

For front height:	Part. No.
100 mm	07-23310
150 mm	07-23315
3 Slotted partitions	36 Eh
6 Aluminium dividers	6 Eh
2 Aluminium dividers	9 Eh

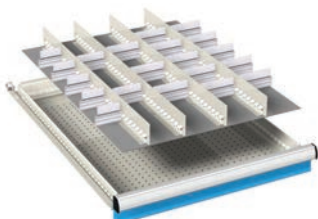

For front height:	Part. No.
100 mm	07-23410
4 Slotted partitions	36 Eh
5 Aluminium dividers	4 Eh
5 Aluminium dividers	5 Eh
10 Aluminium dividers	6 Eh

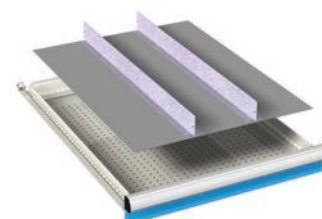

For front height:	Part. No.
100 mm	07-28210
150 mm	07-28215
200 mm	07-28220
2 Plain partitions	36 Eh



Details of partitioning material on page 112



Label holders not included



Standard examples with slotted partitions are supplied with fixings



Series 48

Cantilever Workbenches



Support columns

Made of high-quality steel. Supports included.

Usable height mm	No. of panels required	Part. No.
327	1	48-90008
631	2	48-90016
935	3	48-90024
1239	4	48-90032

For workbench length 1500mm: 2 support columns

For workbench length 2000mm: 3 support columns

Colour: Light grey RAL 7035

8

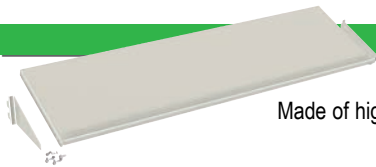

Adjustable shelves

Made of high-quality steel. Supports included.

Worktop length mm	Usable width mm	Usable depth mm	Load capacity kg	No. of shelves required	Part. No.
1500	1299	320	50	1	48-92532
2000	879	320	50	2	48-92032

Incline: 0° / 8° / 15°

Colour: Light grey RAL 7035

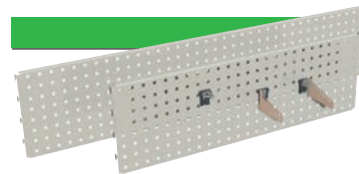

Perforated back panels

Made of high-quality steel.

Worktop length mm	Width mm	Height mm	No. of panels required	Part. No.
1500	1328	304	1	48-91530
2000	908	304	2	48-91030

Colour: Light grey RAL 7035



Hooks see page 249

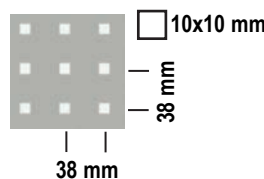

Standard colour:
RAL 7035



Load capacity is intended for evenly distributed loads



Tower cabinets
Made of high-quality steel

To be fixed under the worktop. Available in 2 versions: without door, with Socket block only or with Plexiglas® leaf door and electrical system.

Width mm	Depth mm	Height mm	without Door Part. No.	with Door Socket type Schuko * Part. No.	with Door Socket type UK Part. No.
380	600	600	48-41060	48-42040	48-42046

* With 4 sockets type Schuko (230V) and on/off switch
Different types of sockets are available on request
Colour: Light grey RAL 7035

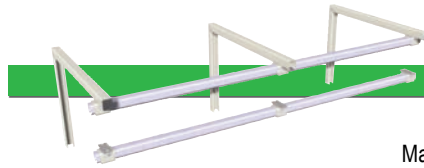

Slide-track

Made of steel. To be fitted to the support columns.

Worktop length mm	Depth mm	Height mm	Load capacity kg	Rail with supports Part. No.	Additional rail Part. No.
1500	660	300	20	40-95115	40-95015
2000	660	300	20	40-95120	40-95020

Colour: Supports in Light grey RAL 7035, rail in galvanised steel

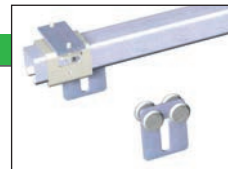

Slider

Made of steel. For rail

Part. No.
40-95001

Load capacity: 3kg

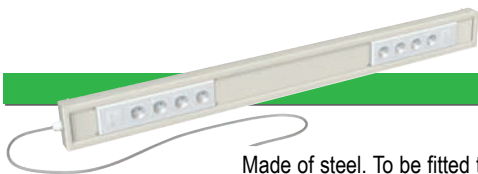

Power trunking

Made of steel. To be fitted to the perforated panel.
With 1m connecting cable

Worktop length mm	Width mm	Depth mm	Height mm	Socket type Schuko Part. No.	Socket type UK Part. No.
1500	1490	55	160	40-06150	40-06156
2000	1990	55	160	40-06200	40-06206

With 6 sockets and on/off switch
Different types of sockets are available on request
Colour: Light grey RAL 7035

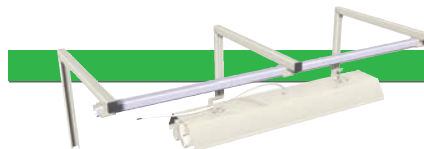

Overhead light

To be fitted to rail

Size mm	Protection	Watt	Light only Part. No.
1000x100x50 mm	IP 66	2x36 W	46-09002

Power cable not supplied



Socket block

To be fitted to the support column.
With 1m connecting cable

Socket type Schuko Part. No.	Socket type UK Part. No.
40-06010	40-06016

Metal support included
With 4 sockets and on/off switch
Different types of sockets are available on request
Colour: Light grey RAL 7035

Standard colour:
RAL 7035





Series 48

Cantilever Workbenches



Depth mm	Height mm	Length 1500 mm Part. No.	Length 2000 mm Part. No.
750	840	48-84157-201	48-84207-201

Fittings:

- 1 Laminated worktop 40 mm thick
- 2 Legs with base
- 2 Leg connection bars



Depth mm	Height mm	Length 1500 mm Part. No.	Length 2000 mm Part. No.
750	840	48-84157-202	48-84207-202

Fittings:

- 1 Laminated worktop 40 mm thick
- 2 Legs with base
- 1 Power trunking with 6 sockets Schuko (230V) and on/off switch
- 2 Leg connection bars



50 S
50 S
100 S

Depth mm	Height mm	Length 1500 mm Part. No.	Length 2000 mm Part. No.
750	840	48-84157-203	48-84207-203

Fittings:

- 1 Laminated worktop 40 mm thick
- 2 Legs with base
- 1 Power trunking with 6 sockets Schuko (230V) and on/off switch
- 1 Cabinet 27x27 Eh with 3 drawers
- 2 Leg connection bars



50 S
50 S
100 S

Depth mm	Height mm	Length 1500 mm Part. No.	Length 2000 mm Part. No.
750	840	48-84157-204	48-84207-204

Fittings:

- 1 Laminated worktop 40 mm thick
- 2 Legs with base
- 1 Power trunking with 6 sockets Schuko (230V) and on/off switch
- 1 Cabinet 27x27 Eh with 3 drawers
- 1 Tower cabinet with Plexiglas® leaf door and electrical system
- 2 Leg connection bars

Standard colour:

RAL 7035



**Standard examples
will require assembly**

Standard examples:



50 S
50 S
100 S

Depth mm	Height mm	Length 1500 mm Part. No.	Length 2000 mm Part. No.
750	840	48-84157-205	48-84207-205

Fittings:

- 1 Laminated worktop 40 mm thick
- 2 Legs with base
- 1 Power trunking with 6 sockets Schuko (230V) and on/off switch
- 1 Cabinet 27x27 Eh with 3 drawers
- 1 Adjustable shelf and support columns
- 2 Leg connection bars



50 S
50 S
100 S

Depth mm	Height mm	Length 1500 mm Part. No.	Length 2000 mm Part. No.
750	840	48-84157-206	48-84207-206

Fittings:

- 1 Laminated worktop 40 mm thick
- 2 Legs with base
- 1 Cabinet 27x27 Eh with 3 drawers
- 1 Perforated back panel
- 1 Adjustable shelf and support columns
- 2 Leg connection bars



50 S
50 S
100 S

Depth mm	Height mm	Length 1500 mm Part. No.	Length 2000 mm Part. No.
750	840	48-84157-207	48-84207-207

Fittings:

- 1 Laminated worktop 40 mm thick
- 2 Legs with base
- 1 Power trunking with 6 sockets Schuko (230V) and on/off switch
- 1 Cabinet 27x27 Eh with 3 drawers
- 1 Perforated back panel
- 1 Adjustable shelf and support columns
- 2 Leg connection bars

Standard colour:

RAL 7035



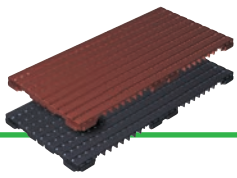

Series 98

Non-slip floor matting

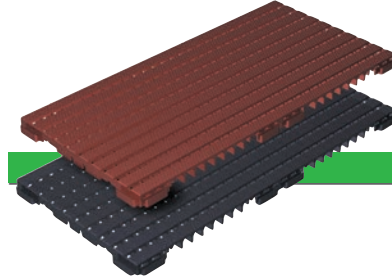

Perforated non-slip floor matting

Made of high density polyethylene ensuring maximum adhesion even in wet conditions. Laid in customised sequences with connection clamps for quick & easy install. Matting has underside channels to cover and protect cabling.

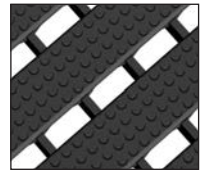

Length mm	Depth mm	Height mm	Brick red Part. No.	Anthracite Part. No.
800	400	25	98-80206	98-80208

8

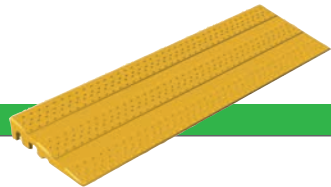

Edging piece - chamfered

Made of high density polyethylene. Clamped to sides of floor matting to increase operator safety and trolley access. Available in yellow.

Length mm	Depth mm	Height mm	Yellow Part. No.
400	120	25	98-79405

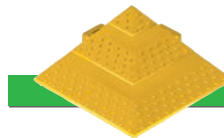

Corner piece - chamfered

Made of high density polyethylene. Clamped to sides of floor matting. Available in yellow.

Length mm	Depth mm	Height mm	Yellow Part. No.
120	120	25	98-79605



Swivel chairs



Polyurethane seat
435x465mm and back
405x310mm, adjustable
height from 620-880mm with
gas pump. Fitted with foot
rest and a 5-leg base.

	Part. No.
with sliders (low noise)	48-24688



Polyurethane seat
435x465mm and back
405x310mm, adjustable
height from 620-880mm with
gas pump.
Fitted with 5-leg base.

	Part. No.
with sliders (low noise)	48-22469
with castors (double-swivel)	48-23469



Polyurethane seat
350x340mm, adjustable
height from 510-710mm.
Fitted with 5-leg base.

	Part. No.
with sliders (low noise)	48-22572



Beech-plywood seat
400x400mm and back
380x180mm, adjustable
height from 810-870mm with
gas pump.
Fitted with foot rest and 5-
leg base.

	Part. No.
with sliders (low noise)	48-14687



Beech-plywood seat
400x400mm and back
380x180mm, adjustable height
from 470-660mm with gas
pump.
Fitted with 5-leg base.

	Part. No.
with sliders (low noise)	48-12466
with castors (double-swivel)	48-13466